



Ministry of Health and Family Welfare
Government of India



Help us to
help you



An Illustrated Guide on COVID Appropriate Behaviour

As you are aware, the COVID 19 pandemic has led to unprecedented and unanticipated challenges requiring collective action and support from all.

While all necessary measures to fight the spread of Novel Corona Virus (COVID 19) are being effectively led by the Central Government and State Governments, there is a need to reinforce the importance of preventive measures and practices in a sustained manner, to deal with the disease over the long run.

This guidebook outlines a comprehensive list of 15 preventive behavioural practices which are critical to winning this fight against the deadly virus.

This fight can be won only when everyone knows their goal; everyone knows their role.

A set of 15 promises, we need to follow, as part of COVID Appropriate Behaviour

1.  Greet without physical contact

2.  Maintain physical distance
2 Gaj ki Doori
(6 feet)

3.  Wear reusable hand-made face-cover or mask, at all times

4.  Avoid touching eyes, nose and mouth

5.  Maintain respiratory hygiene

6.  Wash hands frequently and thoroughly

7.  Regularly clean and disinfect frequently touched surfaces

8.  Do not spit in the open

9.  Avoid unnecessary travel

10.  Do not discriminate against anyone

11.  Discourage crowd - Encourage Safety

12.  Do not circulate social media posts which carry unverified or negative information

13.  Seek information on COVID-19 from credible sources

14.  Call National Toll-free helpline 1075 or State helpline numbers for any queries

15.  Seek psychosocial support for any stress or anxiety

1. Greet without physical contact

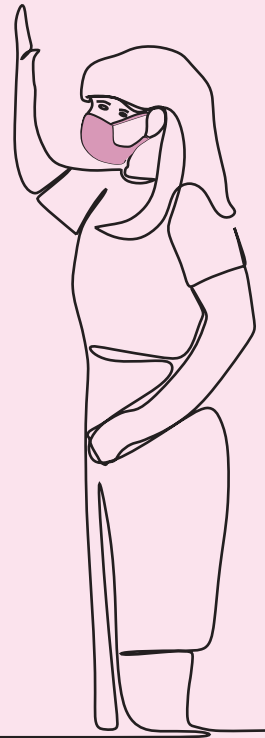

Avoiding physical contact is a responsible behaviour as it prevents the spread of COVID-19 disease and other viruses.

**Be responsible!
Promote greeting without
any form of physical
contact**



2. Maintain Physical distance

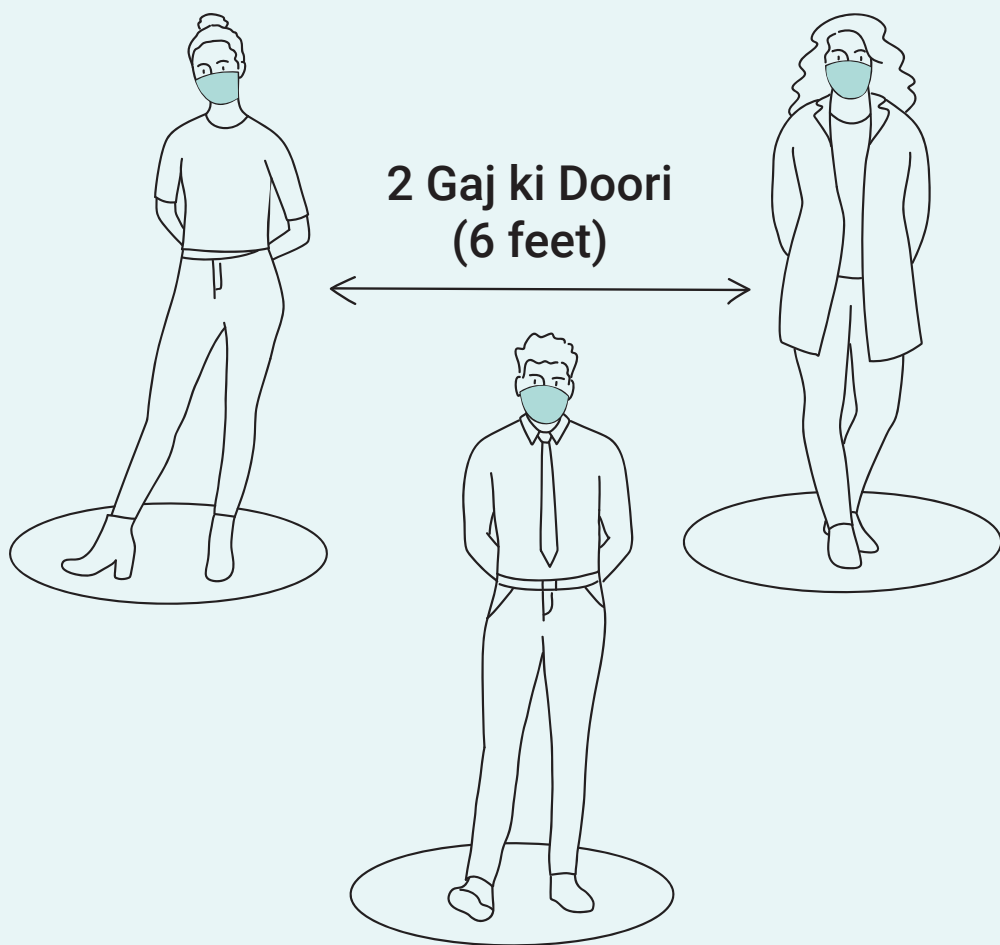

Follow distancing norms
in all public places
Keep minimum distance
of 2 Gaj(6 feet)

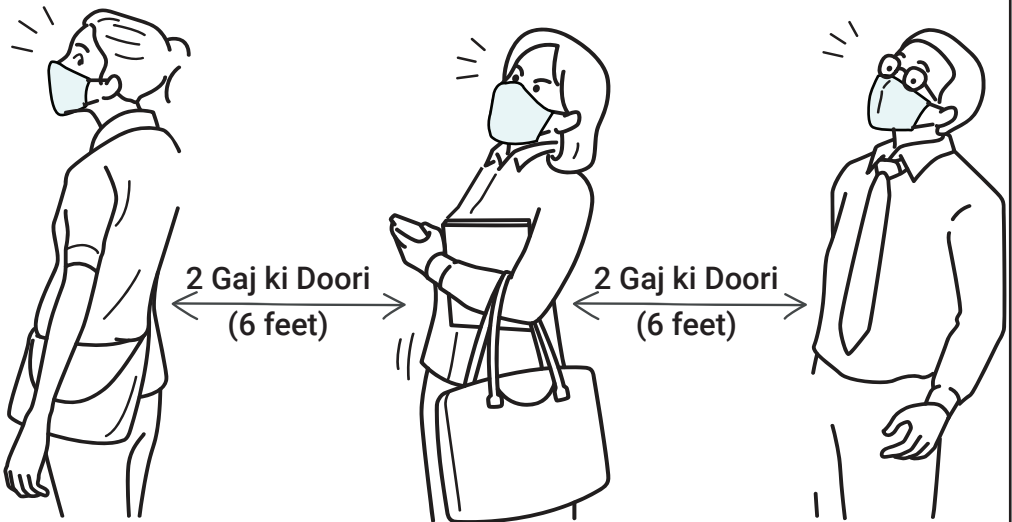
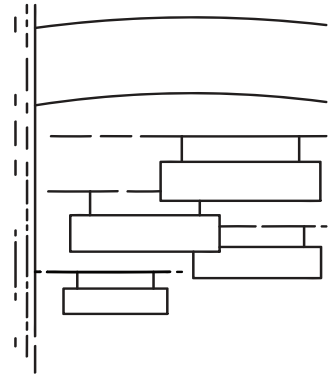
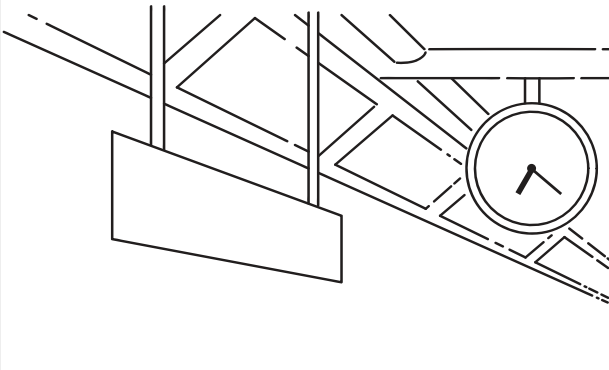

Especially, when you go out to shop for essential products to the vegetable or fruit market, dairy store, pharmacy, hospital, etc....



Also follow distancing norms when in a room / office with other people

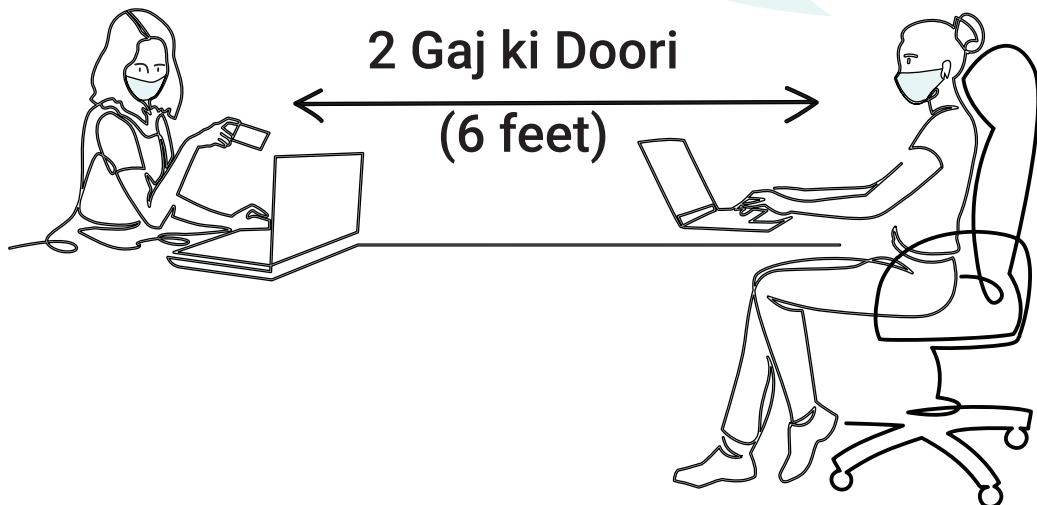

If the other person is infected, their physical contact may increase the risk of transmission

3. Wear reusable hand- made face-cover or mask, at all times



**Why is it necessary to wear
a hand-made
face cover or mask?**



A handmade face cover or mask limits the spread of any respiratory infection and protects the community at large



How to wear a mask



1. Wear mask so nasal clip is over the nose. External pleats should face downwards



2. Open mask pleats so it covers mouth and nose

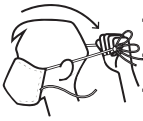

3. Tie upper strings first. Then lower strings. There should be no gap between face and mask



4. Do not touch front of the mask



5. Remove by first untying lower string and then upper string.



6. Replace mask after 8 hours or when damp/humid



7. Dispose the mask in the recommended manner



8. Clean hands after removal of mask

9. Do not reuse single use mask

Do I need to wear a mask at all times?



Remember three key occasions one must definitely wear a face cover or mask



- 1. When you undertake any essential travel or go to a public place**
- 2. When you are in a room with other people**
- 3. When you have any signs of cough, cold or flu**

You can easily make a face cover at home to protect yourself

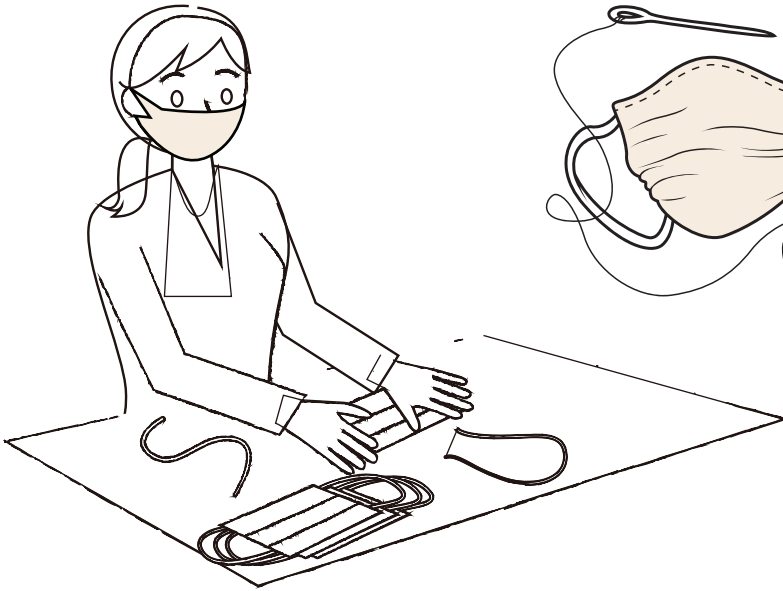

Really?



**Yes, just log on to www.mohfw.gov.in
and read the manual on how to make a
face cover**



Always remember, wash hands with soap and water or use an alcohol based sanitizer before wearing a mask

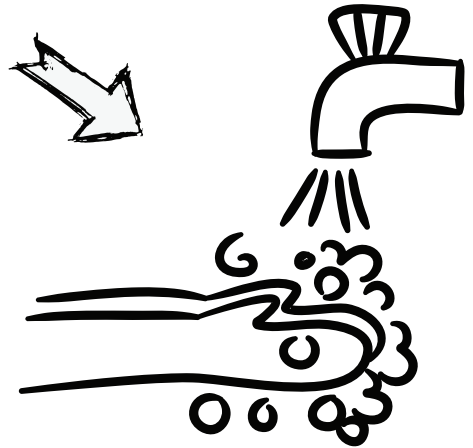
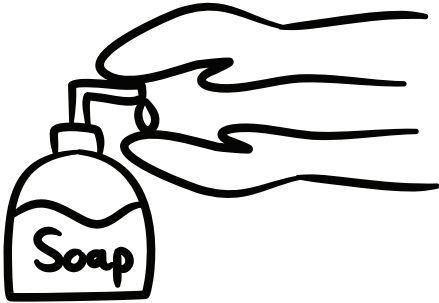

4. Avoid touching your eyes, nose or mouth



We tend to touch our face inadvertently...
let's be extra careful



But Why?





**Hands touch many surfaces
and can easily pick up germs
and viruses**



**Once contaminated, hands
can transfer the virus to
your eyes, nose or mouth**

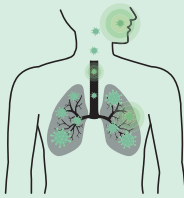

**From there, the virus
can enter your body
and can make you sick**



**Your safety is in your own hands-
quite literally!**

5. Maintain respiratory hygiene

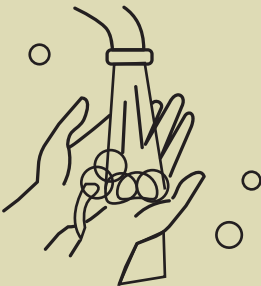

Cover your nose and mouth when you cough or sneeze with tissue or handkerchief



**Not carrying a tissue or
handkerchief?
Cough or sneeze into
your bent elbow**



**Don't forget...
Wash hands
immediately after you
cough or sneeze**



6. Wash hands frequently and thoroughly!



Your safety is in your hands – Literally!



Wash your hands frequently and thoroughly with soap and water

**Meet our hand
hygiene superheroes**

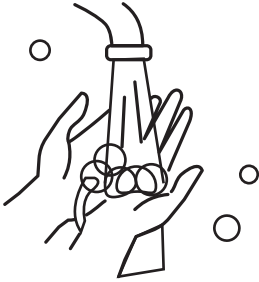

**Frequently hand-wash with me using water.
I am there to protect you from any virus,
including COVID-19**



ALCOHOL-BASED HAND SANITIZER
**You can use me if you don't have
soap and water facility.**

7. Regularly clean and disinfect frequently touched surfaces



Practicing good environmental hygiene makes your surroundings safer.

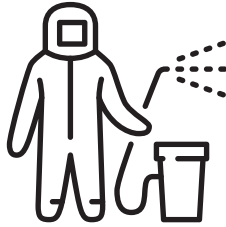

How is that?



Because the infected droplets are likely to settle on surrounding surfaces.

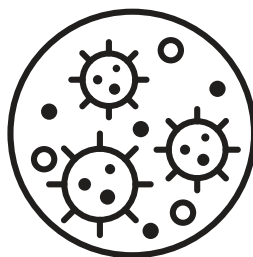

You may use chemical disinfectants to clean the surfaces

But wait...
Don't forget to wear gloves during disinfection



8. Do not spit in the open



Every time you spit in a public place, you put your and everyone else's life at risk

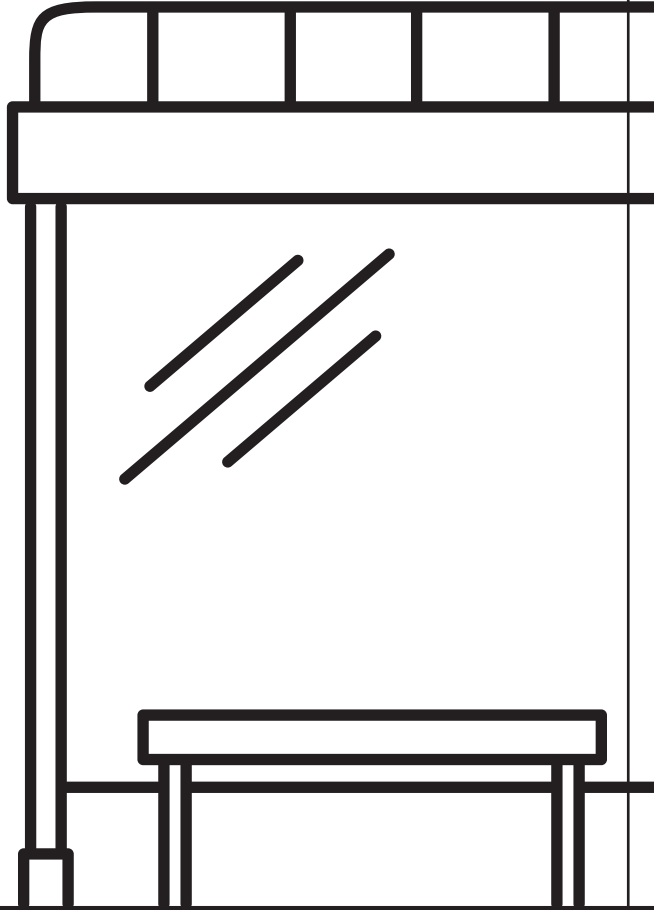
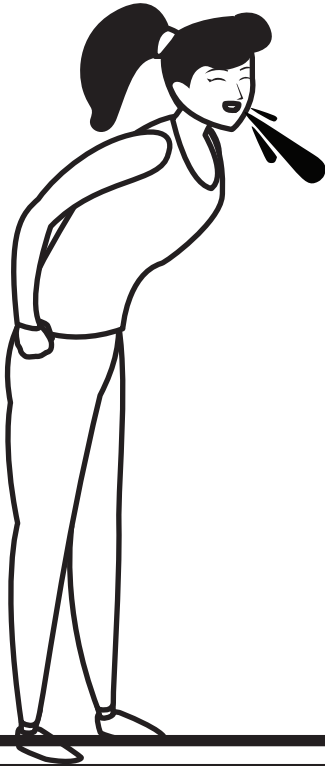

**Spitting in public places
can increase the risk of
COVID-19 spread**



**This also includes spitting
after consuming smokeless
tobacco products**



Remember - Spitting in public places is also punishable by law

9. Avoid unnecessary travel

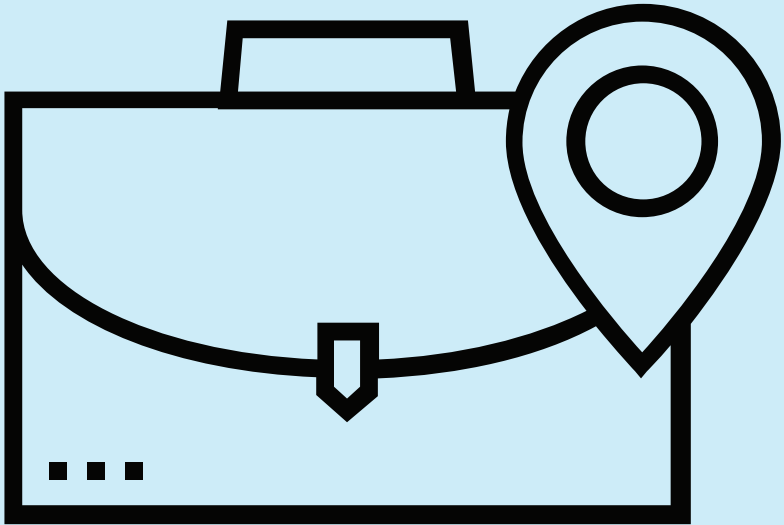

Travel only when it's absolutely essential

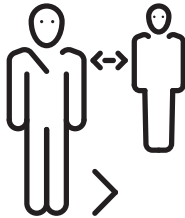

2 Gaj ki Doori
(6 feet)

And if you do step out of your house...

Wear your face-cover and follow distancing norms

10. Do not discriminate - Against anyone!





Show compassion and support to persons affected with COVID-19 and their families

Remember – As people keep a check on any symptoms associated with COVID-19 and are willing to undergo testing, they also provide an opportunity to beat the disease!



Download the Aarogya Setu app to monitor your health



Boost the morale of doctors, nurses, police, sanitation workers who are on guard 24X7 to protect us



**It is time to show CARE
Compassion
Assurance
Respect
Encouragement**

11. Discourage crowd - Encourage safety

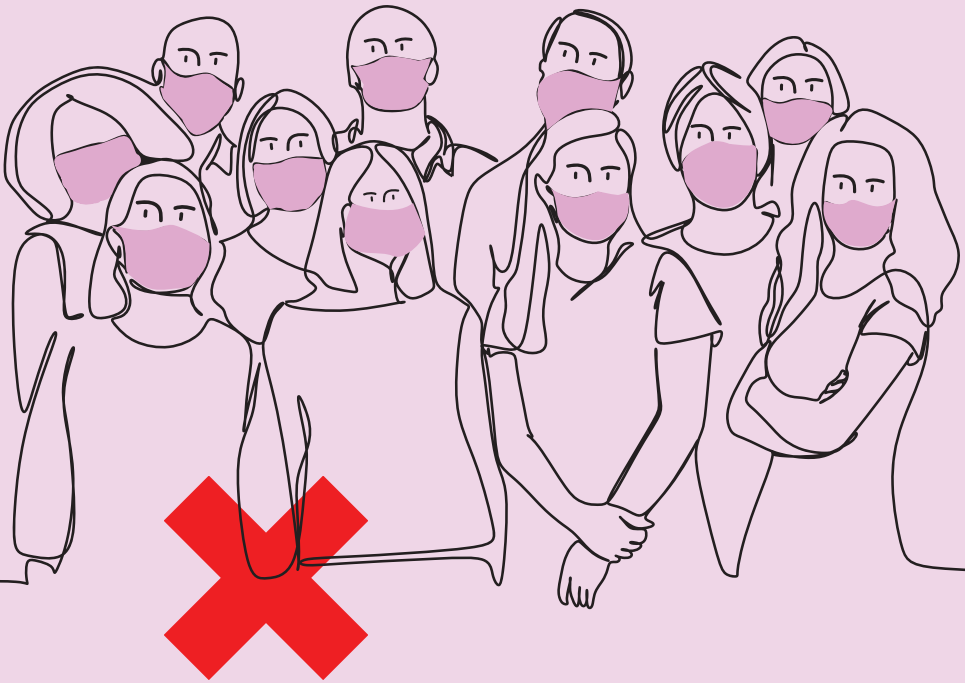

Limit going to social gatherings and say no to crowded places.

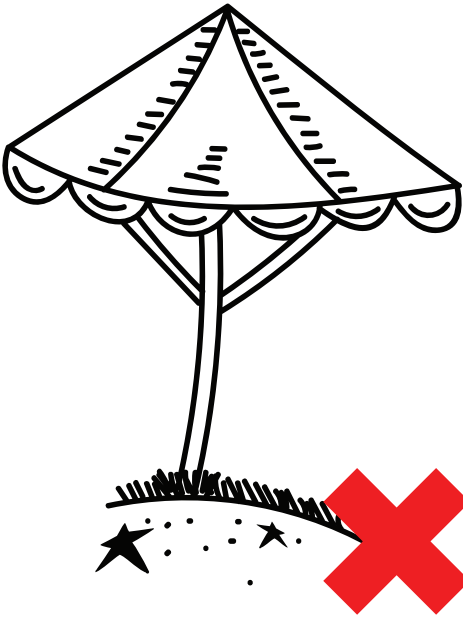
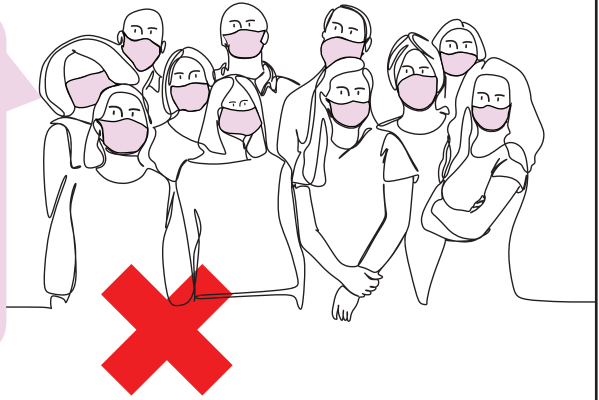

Unnecessary travel to crowded places or large gatherings increases the risk of COVID-19 transmission!

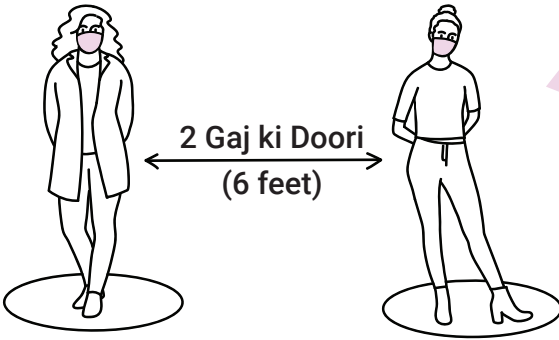

Keep a reasonable distance of atleast 2 Gaj(6 feet) from others

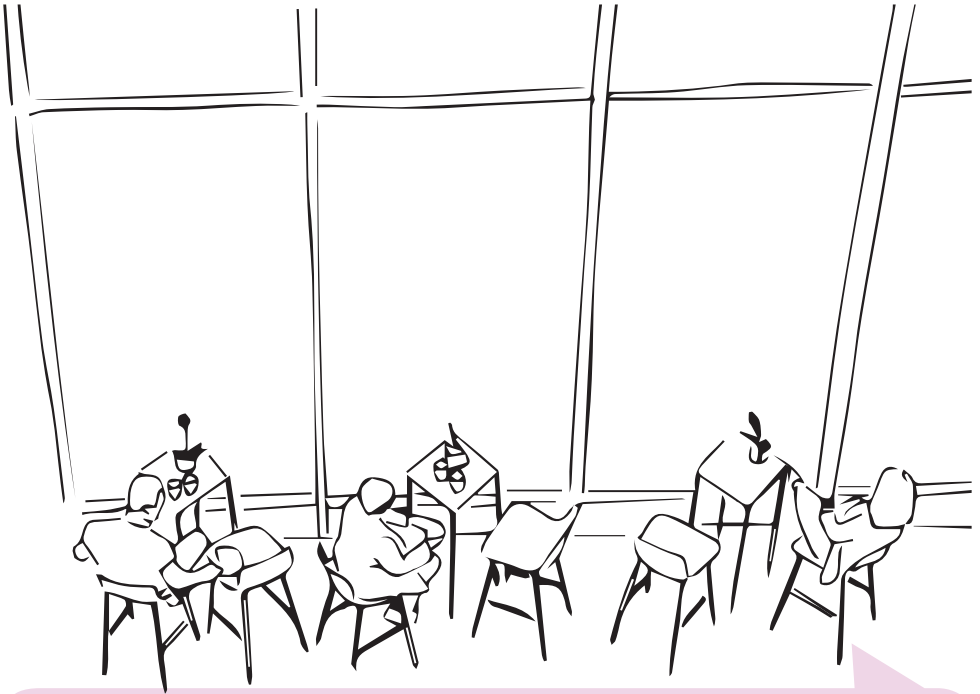

For important events which cannot be postponed, keep the number of guests to minimal



**Oh, have you tried connecting with your loved ones and colleagues virtually?
Try it, it is much safer!**

12. Do not circulate social media posts which carry unverified or negative information

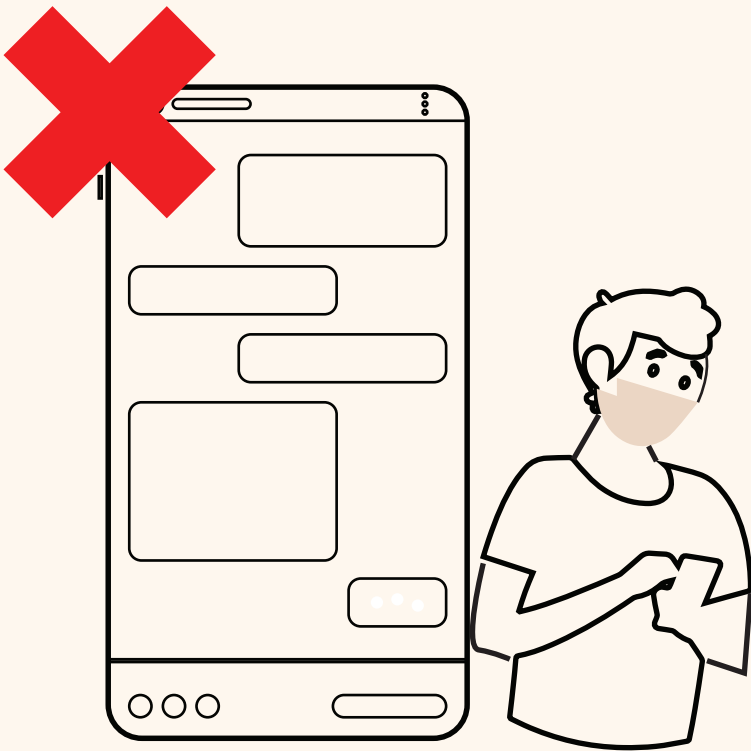

13. Seek information on COVID-19 from credible sources

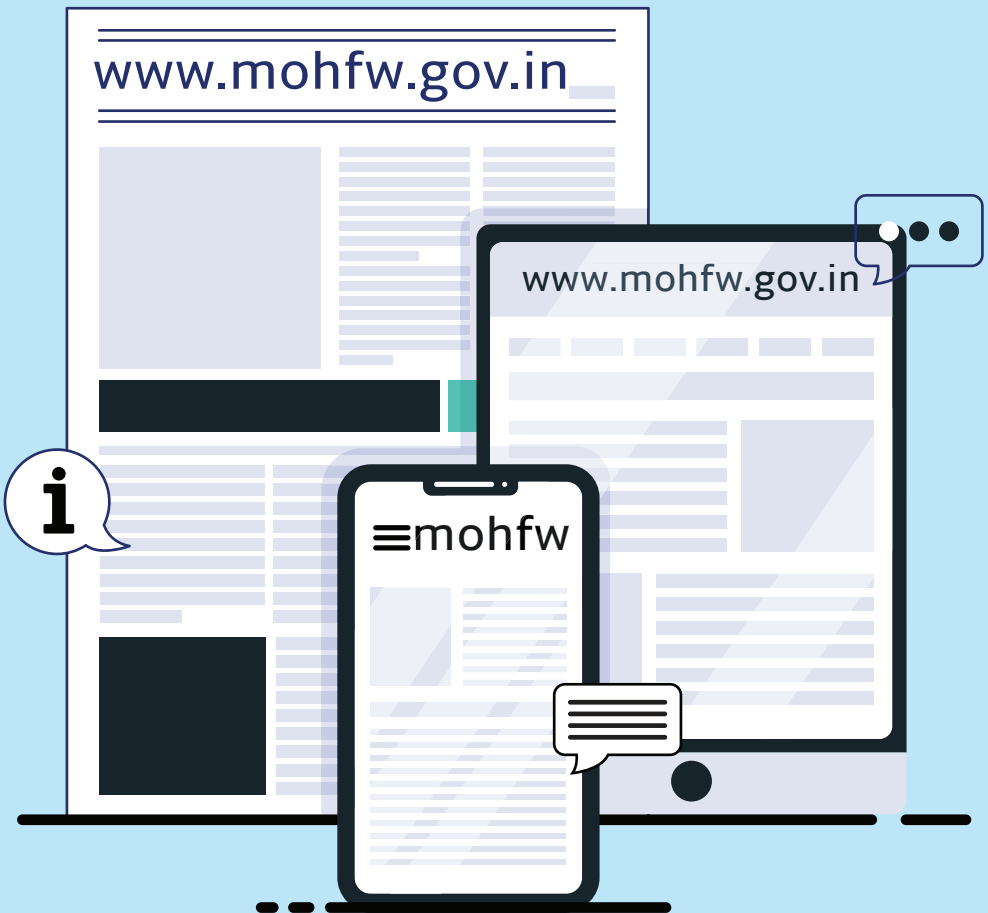



There is COVID-19 related information coming in from so many sources. Which one should I rely on?

The most credible source for COVID-19 information is Ministry of Health and Family Welfare's website (www.mohfw.com). You will receive all updated information and facts related to COVID-19 here.



14. Call national toll free helpline numbers 1075 or State helpline numbers for any COVID-19 related queries





If you have any COVID-19 related queries or observe any COVID-19 related symptoms like fever, cough, or difficulty in breathing, call the national helpline number 1075 (toll free)



Do not hesitate to disclose your symptoms

**The earlier you seek help, the faster you will beat
the disease!**

15. Seek psychosocial support in case of any distress or anxiety

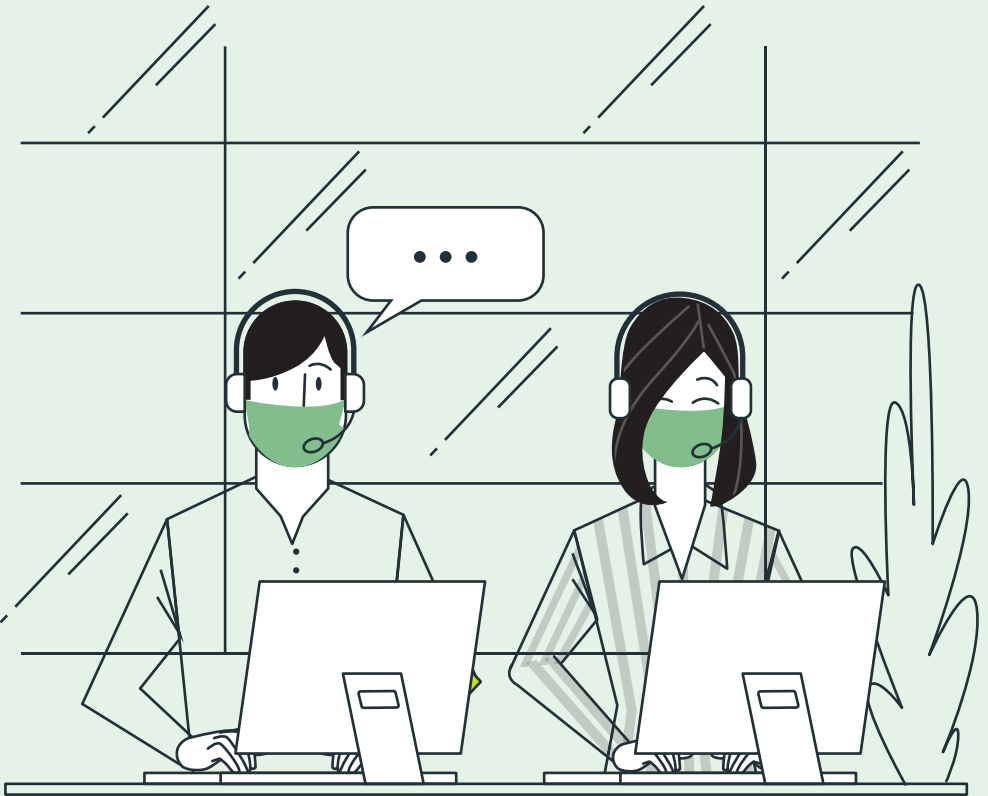



Coping with any public emergency or outbreak can be a testing time for people and their families – both affected or unaffected



Do not ignore or suppress any feelings of anxiety or distress



**Psychosocial support services are available
at all times for you,
to address any stress or distress related
queries and concerns**

**Call on national psychosocial
toll-free helpline number
08046110007**



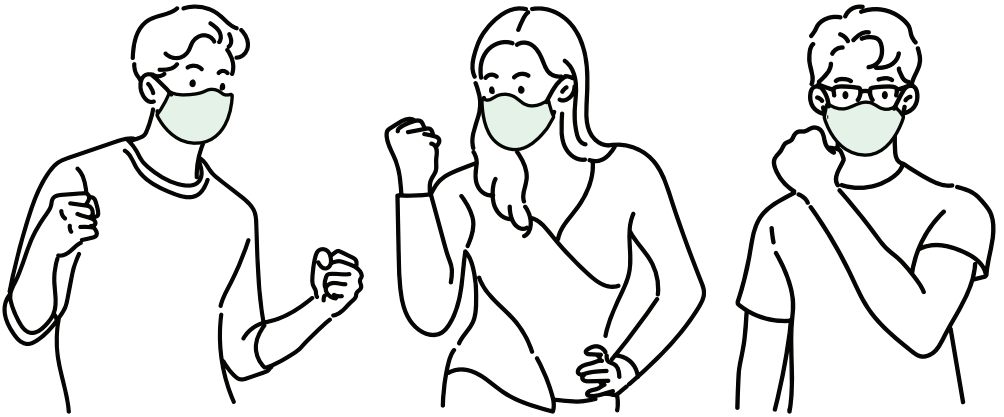

**Together,
we will fight COVID-19!**